

- ▶ Hydraulic Disc Brake System
- ▶ Fairlead 4-Way Roller and Rope Stabilizer Including
- ▶ 25 m Rope and Hook Including
- ▶ Manual Winch Discharge System is standard

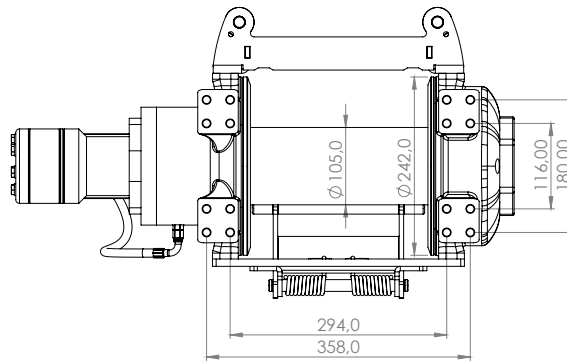
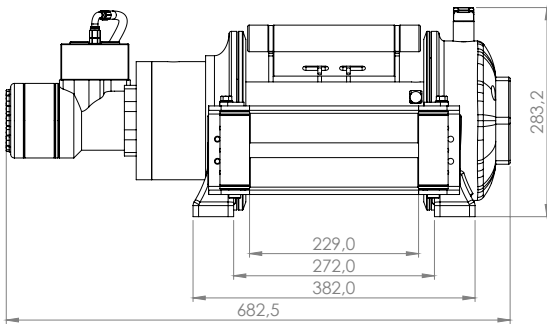
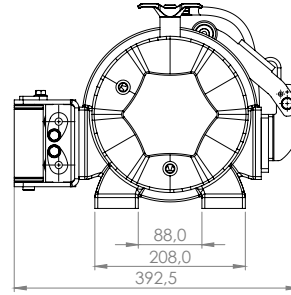
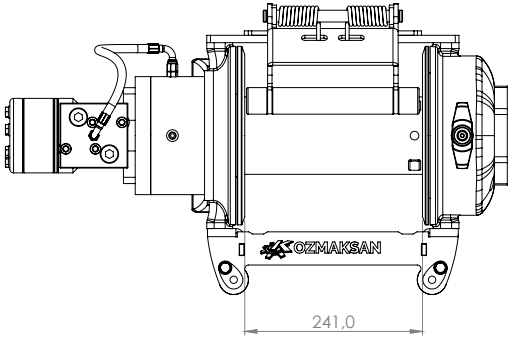
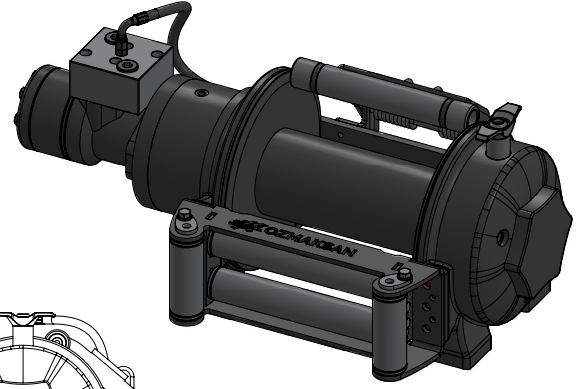

Rope Winding Count	Pulling Capacity kg
1	6800
2	5635
3	4815
4	4200
5	3725

Maximum Pulling Force	: 6800 kg
Maximum Rope Diameter	: 12mm
Maximum Pump Flow	: 60L
Maximum Operating Pressure	: 155 bar
Recommended Gear Oil Product	: 80w 90 - 0.80L
Weight	: 82 kg