

- ▶ Hydraulic Disc Brake System
- ▶ Fairlead 4-Way Roller and Rope Stabilizer Including
- ▶ 25 m Rope and Hook Including
- ▶ Manual Winch Discharge System is standard

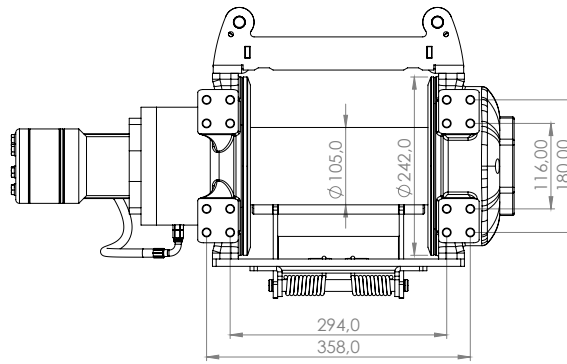
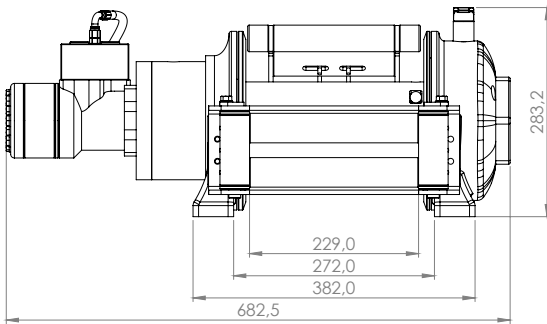
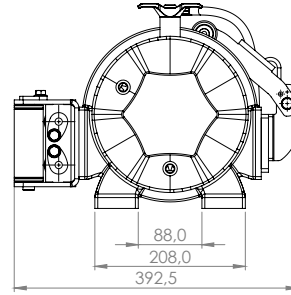
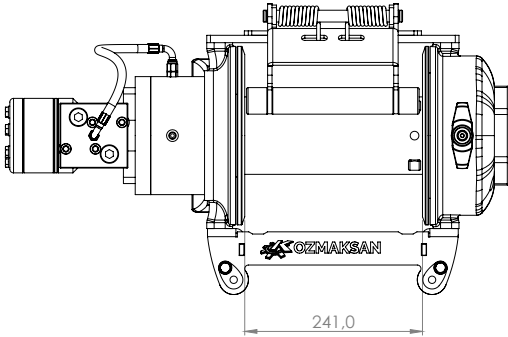
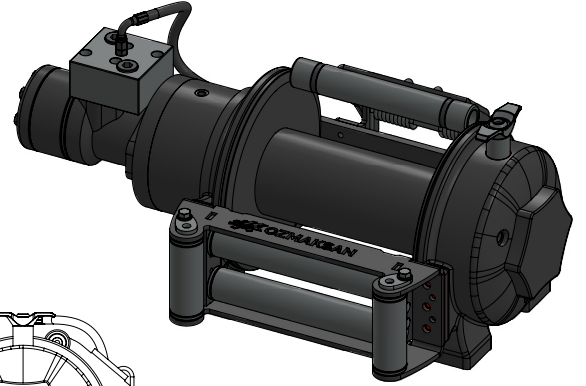

Rope Winding Count	Pulling Capacity kg
1	7200
2	5880
3	4940
4	4250
5	3740

Maximum Pulling Force	: 7200 kg
Maximum Rope Diameter	: 14mm
Maximum Pump Flow	: 60L
Maximum Operating Pressure	: 165 bar
Recommended Gear Oil Product	: 80w 90 - 0.80L
Weight	: 84 kg